

HALF-BRIDGE DRIVER

Features

- Floating channel designed for bootstrap operation
 Fully operational to +600V
 Tolerant to negative transient voltage
 dV/dt immune
- Gate drive supply range from 10 to 20V
- Undervoltage lockout
- 3.3V, 5V and 15V logic compatible
- Cross-conduction prevention logic
- Matched propagation delay for both channels
- Internal set deadtime
- High side output in phase with HIN input
- Low side output out of phase with LIN input

Description

The IR2103(S) are high voltage, high speed power MOSFET and IGBT drivers with dependent high and low side referenced output channels. Proprietary HVIC and latch immune CMOS technologies enable ruggedized monolithic construction. The logic input is compatible with standard CMOS or LSTTL output, down to 3.3V logic. The output drivers feature a high pulse current buffer stage designed for minimum driver cross-conduction. The floating channel can be used to drive an N-channel power MOSFET or IGBT in the high side configuration which operates up to 600 volts.

Product Summary

| | |
|----------------------------|-----------------|
| V_{OFFSET} | 600V max. |
| $I_{\text{O+/-}}$ | 130 mA / 270 mA |
| V_{OUT} | 10 - 20V |
| $t_{\text{on/off (typ.)}}$ | 680 & 150 ns |
| Deadtime (typ.) | 520 ns |

Packages

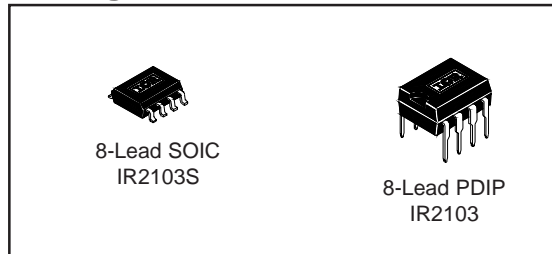

Typical Connection

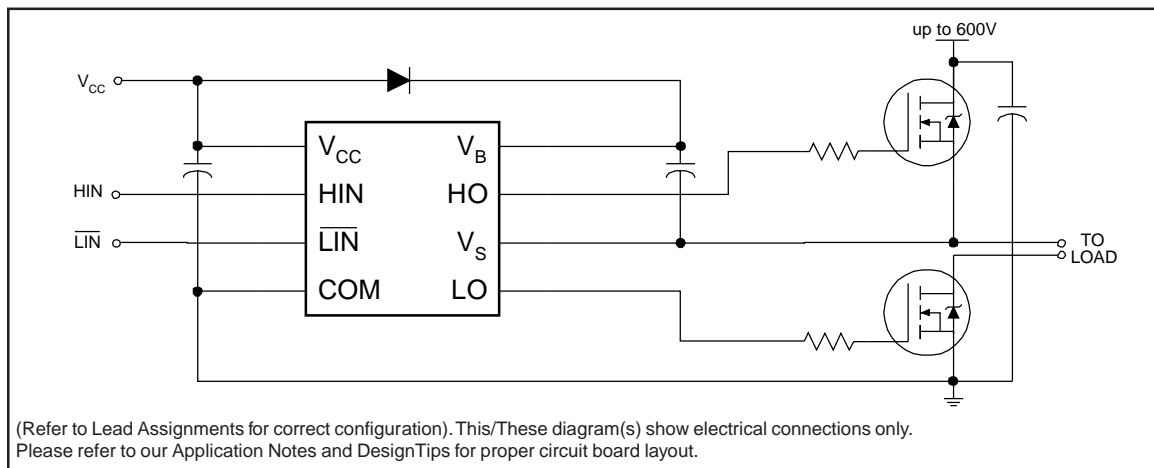

IR2103(S)

Absolute Maximum Ratings

Absolute maximum ratings indicate sustained limits beyond which damage to the device may occur. All voltage parameters are absolute voltages referenced to COM. The thermal resistance and power dissipation ratings are measured under board mounted and still air conditions.

| Symbol | Definition | Min. | Max. | Units | |
|---------------------|--|----------------------|-----------------------|-------|------|
| V _B | High side floating absolute voltage | -0.3 | 625 | V | |
| V _S | High side floating supply offset voltage | V _B - 25 | V _B + 0.3 | | |
| V _{HO} | High side floating output voltage | V _S - 0.3 | V _B + 0.3 | | |
| V _{CC} | Low side and logic fixed supply voltage | -0.3 | 25 | | |
| V _{LO} | Low side output voltage | -0.3 | V _{CC} + 0.3 | | |
| V _{IN} | Logic input voltage (HIN & LIN) | -0.3 | V _{CC} + 0.3 | | |
| dV _S /dt | Allowable offset supply voltage transient | — | 50 | V/ns | |
| P _D | Package power dissipation @ T _A ≤ +25°C | (8 Lead PDIP) | — | 1.0 | W |
| | | (8 Lead SOIC) | — | 0.625 | |
| R _{thJA} | Thermal resistance, junction to ambient | (8 Lead PDIP) | — | 125 | °C/W |
| | | (8 Lead SOIC) | — | 200 | |
| T _J | Junction temperature | — | 150 | °C | |
| T _S | Storage temperature | -55 | 150 | | |
| T _L | Lead temperature (soldering, 10 seconds) | — | 300 | | |

Recommended Operating Conditions

The input/output logic timing diagram is shown in figure 1. For proper operation the device should be used within the recommended conditions. The V_S offset rating is tested with all supplies biased at 15V differential.

| Symbol | Definition | Min. | Max. | Units |
|-----------------|--|---------------------|---------------------|-------|
| V _B | High side floating supply absolute voltage | V _S + 10 | V _S + 20 | V |
| V _S | High side floating supply offset voltage | Note 1 | 600 | |
| V _{HO} | High side floating output voltage | V _S | V _B | |
| V _{CC} | Low side and logic fixed supply voltage | 10 | 20 | |
| V _{LO} | Low side output voltage | 0 | V _{CC} | |
| V _{IN} | Logic input voltage (HIN & LIN) | 0 | V _{CC} | °C |
| T _A | Ambient temperature | -40 | 125 | |

Note 1: Logic operational for V_S of -5 to +600V. Logic state held for V_S of -5V to -V_{BS}. (Please refer to the Design Tip DT97-3 for more details).

Dynamic Electrical Characteristics

V_{BIAS} (V_{CC} , V_{BS}) = 15V, C_L = 1000 pF and T_A = 25°C unless otherwise specified.

| Symbol | Definition | Min. | Typ. | Max. | Units | Test Conditions |
|-----------|---|------|------|------|-------|-----------------|
| t_{on} | Turn-on propagation delay | — | 680 | 820 | ns | $V_S = 0V$ |
| t_{off} | Turn-off propagation delay | — | 150 | 220 | | $V_S = 600V$ |
| t_r | Turn-on rise time | — | 100 | 170 | | |
| t_f | Turn-off fall time | — | 50 | 90 | | |
| DT | Deadtime, LS turn-off to HS turn-on & HS turn-on to LS turn-off | 400 | 520 | 650 | | |
| MT | Delay matching, HS & LS turn-on/off | — | — | 60 | | |

Static Electrical Characteristics

V_{BIAS} (V_{CC} , V_{BS}) = 15V and T_A = 25°C unless otherwise specified. The V_{IN} , V_{TH} and I_{IN} parameters are referenced to COM. The V_O and I_O parameters are referenced to COM and are applicable to the respective output leads: HO or LO.

| Symbol | Definition | Min. | Typ. | Max. | Units | Test Conditions |
|-------------|--|------|------|------|---------|--|
| V_{IH} | Logic "1" (HIN) & Logic "0" (\overline{LIN}) input voltage | 3 | — | — | V | $V_{CC} = 10V$ to 20V |
| V_{IL} | Logic "0" (HIN) & Logic "1" (\overline{LIN}) input voltage | — | — | 0.8 | | $V_{CC} = 10V$ to 20V |
| V_{OH} | High level output voltage, $V_{BIAS} - V_O$ | — | — | 100 | mV | $I_O = 0A$ |
| V_{OL} | Low level output voltage, V_O | — | — | 100 | | $I_O = 0A$ |
| I_{LK} | Offset supply leakage current | — | — | 50 | μA | $V_B = V_S = 600V$ |
| I_{QBS} | Quiescent V_{BS} supply current | — | 30 | 55 | | $V_{IN} = 0V$ or 5V |
| I_{QCC} | Quiescent V_{CC} supply current | — | 150 | 270 | | $V_{IN} = 0V$ or 5V |
| I_{IN+} | Logic "1" input bias current | — | 3 | 10 | | HIN = 5V, $\overline{LIN} = 0V$ |
| I_{IN-} | Logic "0" input bias current | — | — | 1 | | HIN = 0V, $\overline{LIN} = 5V$ |
| V_{CCUV+} | V_{CC} supply undervoltage positive going threshold | 8 | 8.9 | 9.8 | V | |
| V_{CCUV-} | V_{CC} supply undervoltage negative going threshold | 7.4 | 8.2 | 9 | | |
| I_{O+} | Output high short circuit pulsed current | 130 | 210 | — | mA | $V_O = 0V, V_{IN} = V_{IH}$ $PW \leq 10 \mu s$ |
| I_{O-} | Output low short circuit pulsed current | 270 | 360 | — | | $V_O = 15V, V_{IN} = V_{IL}$ $PW \leq 10 \mu s$ |

IR2103(S)

Functional Block Diagram

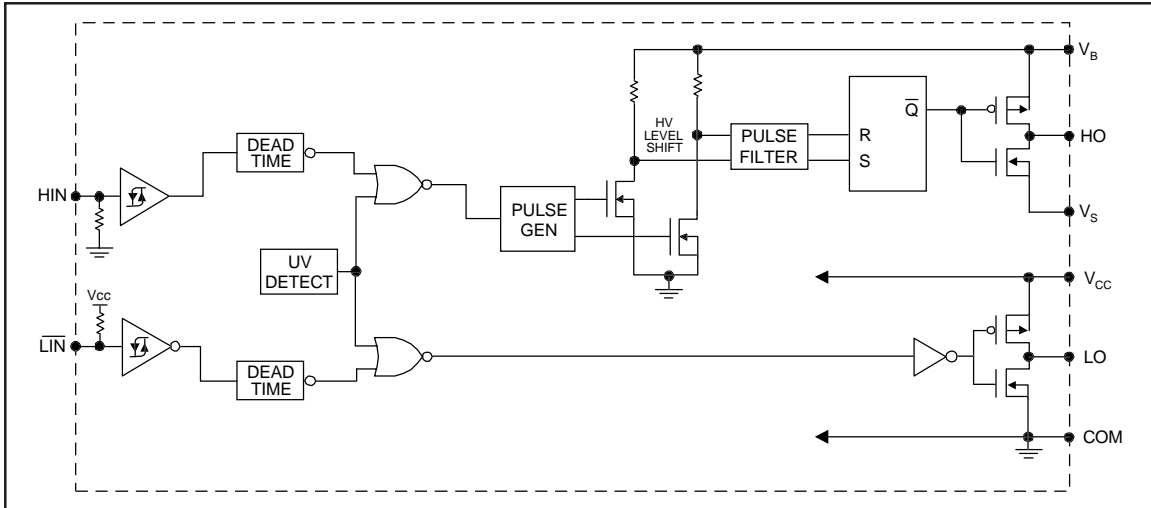

Lead Definitions

| Symbol | Description |
|-------------------------|--|
| HIN | Logic input for high side gate driver output (HO), in phase |
| $\overline{\text{LIN}}$ | Logic input for low side gate driver output (LO), out of phase |
| VB | High side floating supply |
| HO | High side gate drive output |
| VS | High side floating supply return |
| VCC | Low side and logic fixed supply |
| LO | Low side gate drive output |
| COM | Low side return |

Lead Assignments

| | |
|--------------------|--------------------|
| <p>8 Lead PDIP</p> | <p>8 Lead SOIC</p> |
| IR2103 | IR2103S |

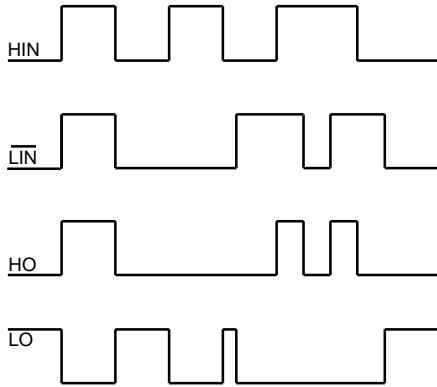

Figure 1. Input/Output Timing Diagram

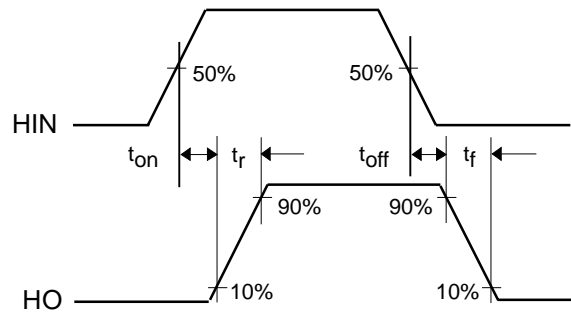
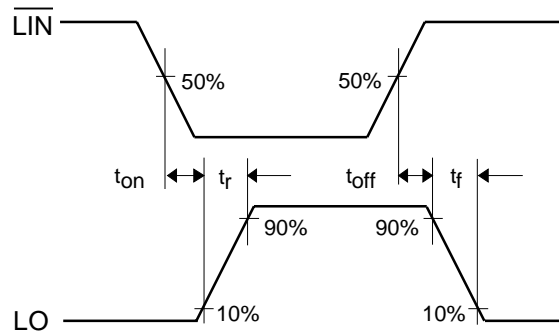

Figure 2. Switching Time Waveform Definitions

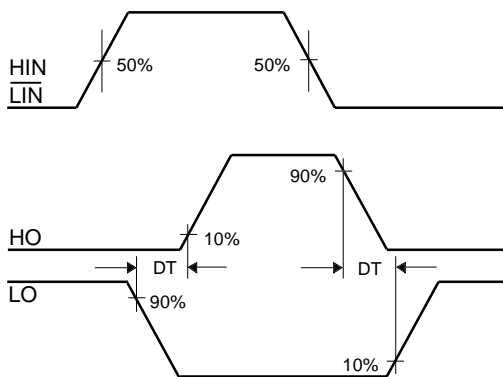

Figure 4. Deadtime Waveform Definitions

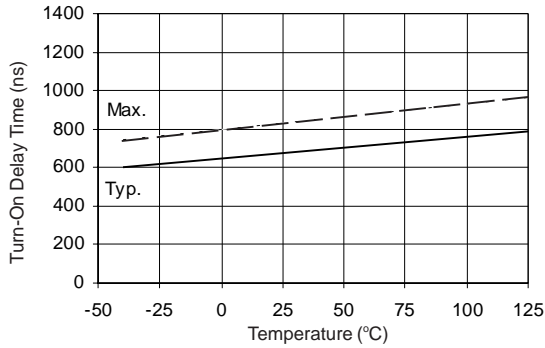

Figure 6A. Turn-On Time vs Temperature

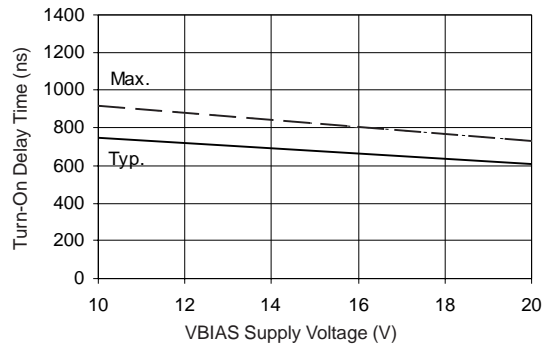

Figure 6B. Turn-On Time vs Supply Voltage

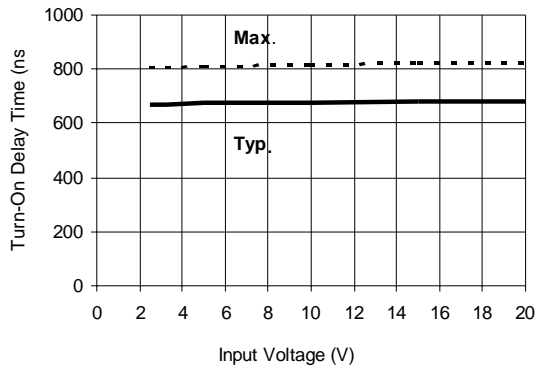

Figure 6C. Turn-On Time vs Input Voltage

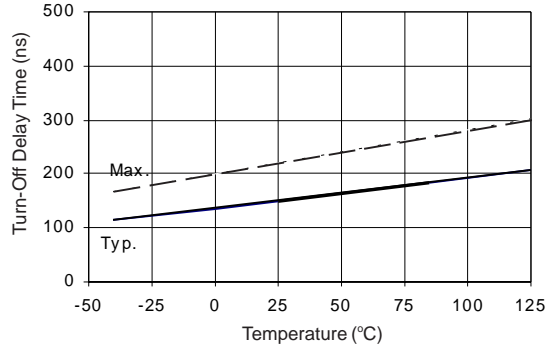

Figure 7A. Turn-Off Time vs Temperature

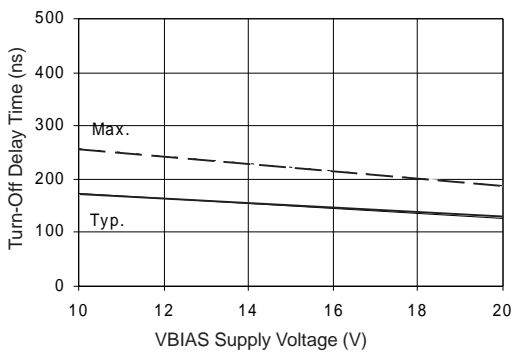

Figure 7B. Turn-Off Time vs Supply Voltage

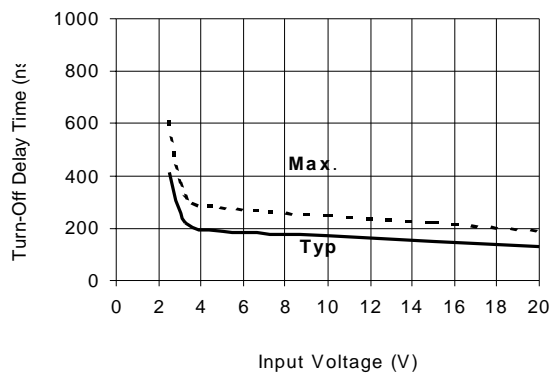

Figure 7C. Turn-Off Time vs Input Voltage

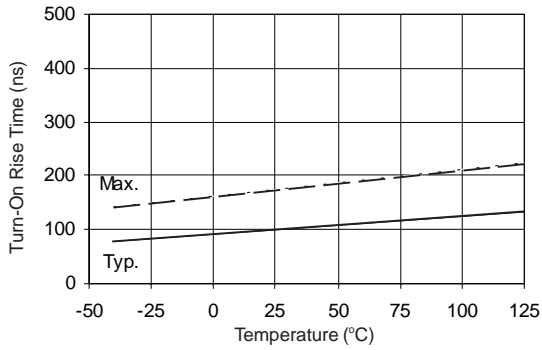

Figure 9A. Turn-On Rise Time vs Temperature

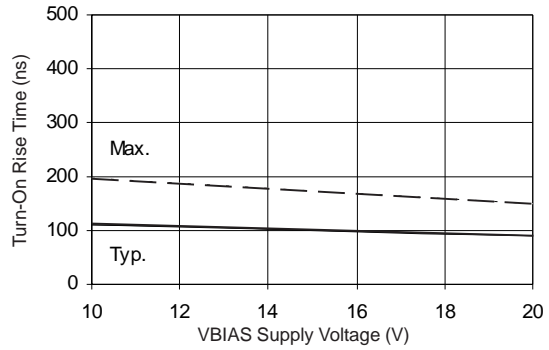

Figure 9B. Turn-On Rise Time vs Voltage

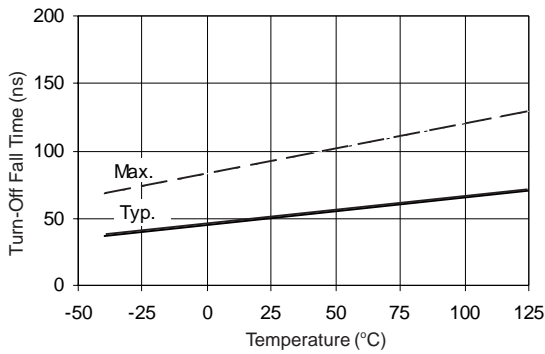

Figure 10A. Turn Off Fall Time vs Temperature

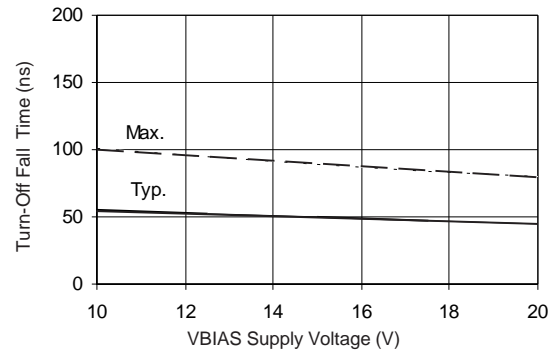

Figure 10B. Turn Off Fall Time vs Voltage

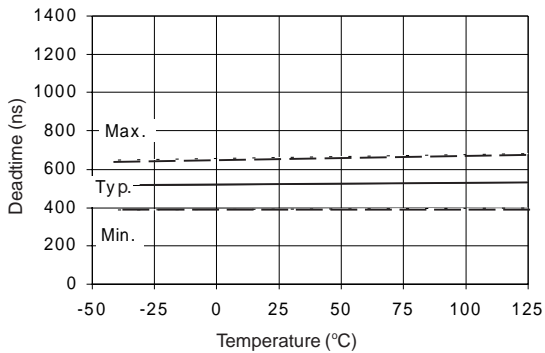

Figure 11A. Deadtime vs Temperature

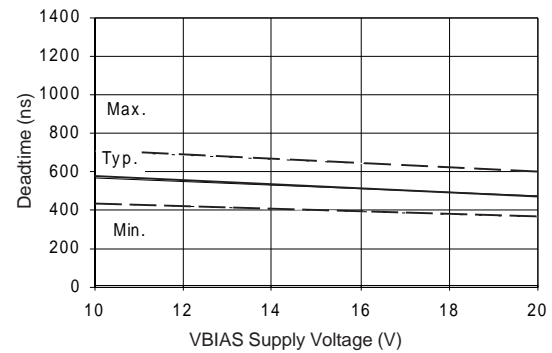

Figure 11B. Deadtime vs Voltage

IR2103(S)

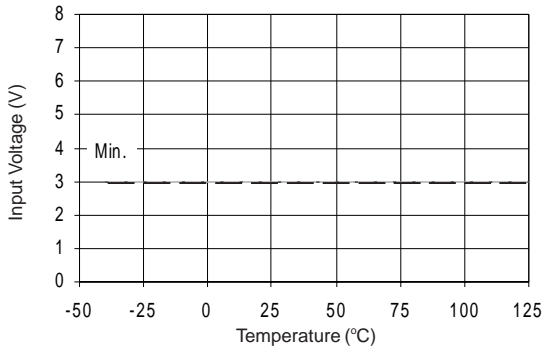

Figure 12A. Logic "1" (\overline{HIN}) & Logic "0" (\overline{LIN}) Input Voltage vs Temperature

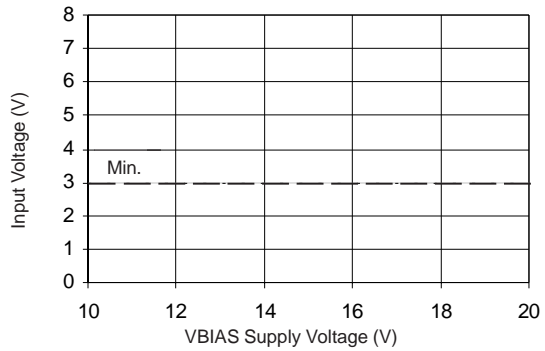

Figure 12B. Logic "1" (\overline{HIN}) & Logic "0" (\overline{LIN}) Input Voltage vs Voltage

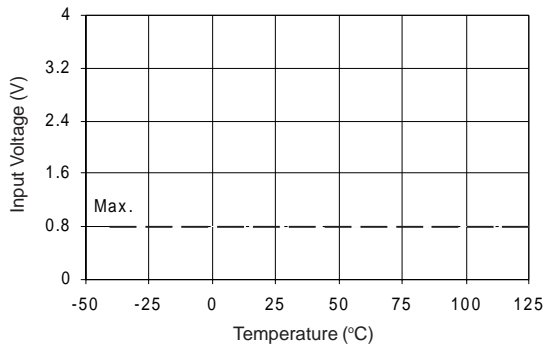

Figure 13A. Logic "0" (\overline{HIN}) & Logic "1" (\overline{LIN}) Input Voltage vs Temperature

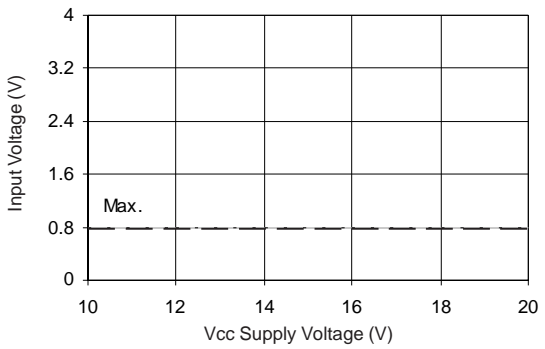

Figure 13B. Logic "0" (\overline{HIN}) & Logic "1" (\overline{LIN}) Input Voltage vs Voltage

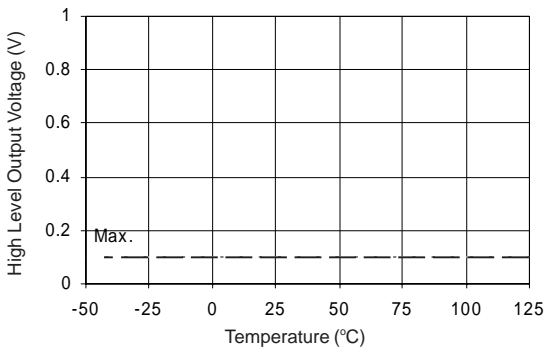

Figure 14A. High Level Output vs Temperature

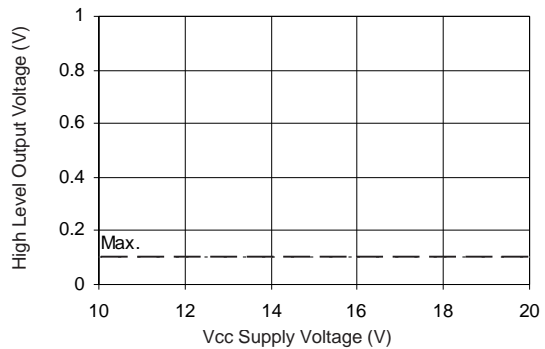

Figure 14B. High Level Output vs Voltage

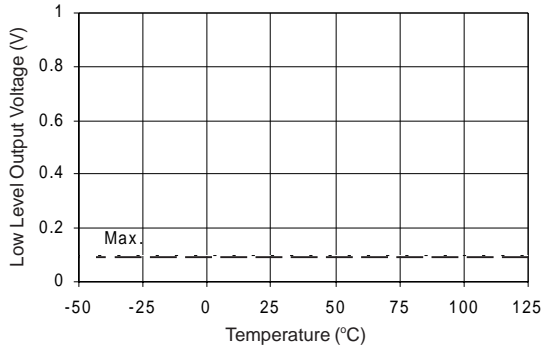

Figure 15A. Low Level Output vs Temperature

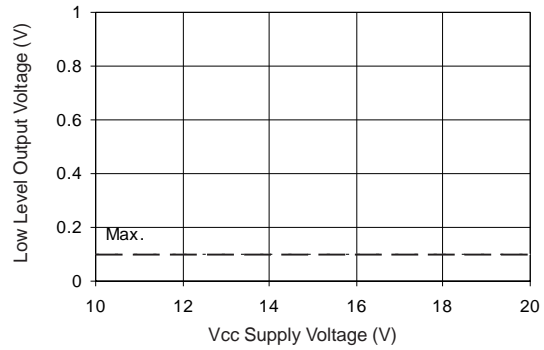

Figure 15B. Low Level Output vs Voltage

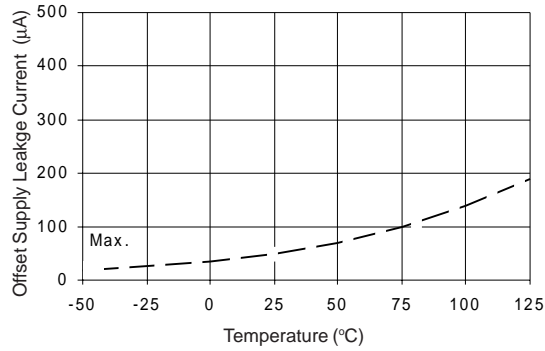

Figure 16A. Offset Supply Current vs Temperature

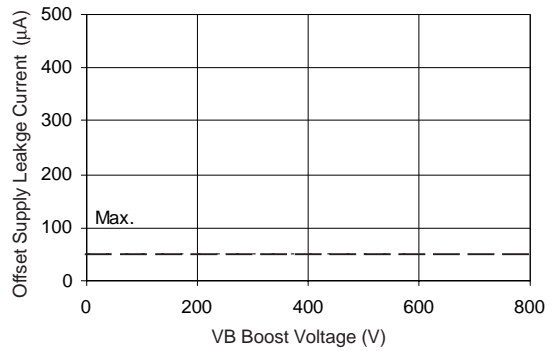

Figure 16B. Offset Supply Current vs Voltage

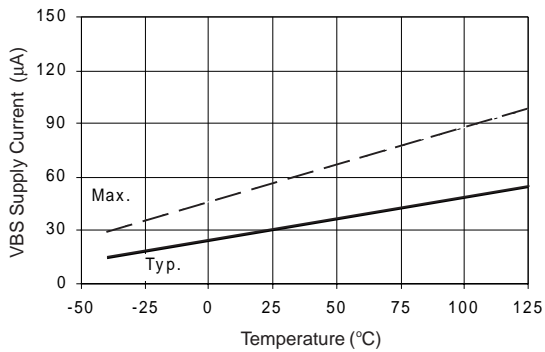

Figure 17A. VBS Supply Current vs Temperature

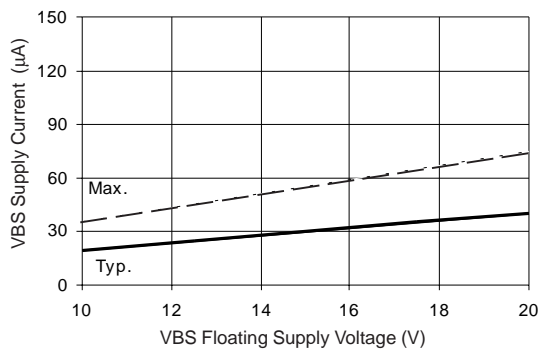

Figure 17B. VBS Supply Current vs Voltage

IR2103(S)

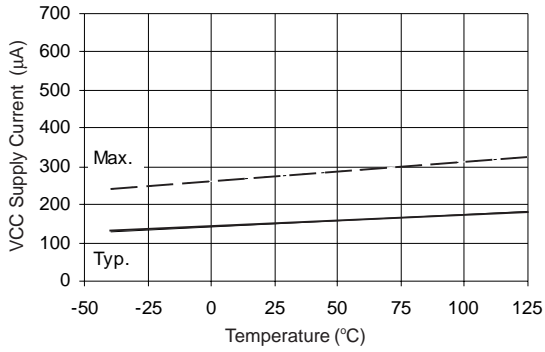

Figure 18A. Vcc Supply Current vs Temperature

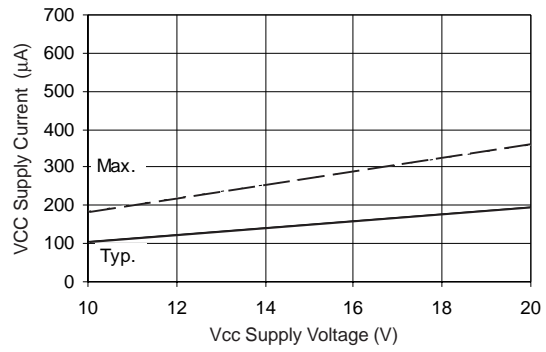

Figure 18B. Vcc Supply Current vs Voltage

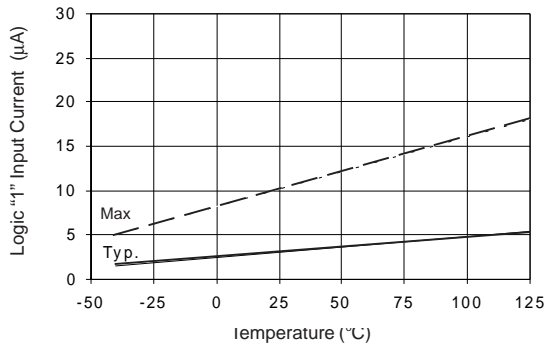

Figure 19A. Logic "1" Input Current vs Temperature

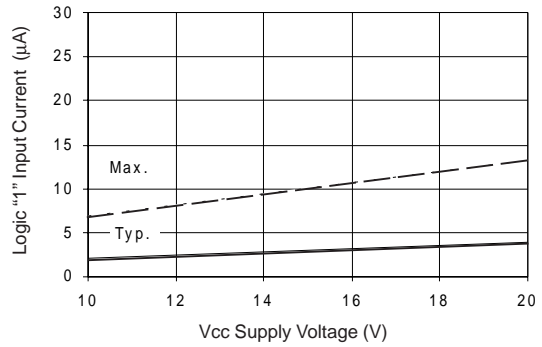

Figure 19B. Logic "1" Input Current vs Voltage

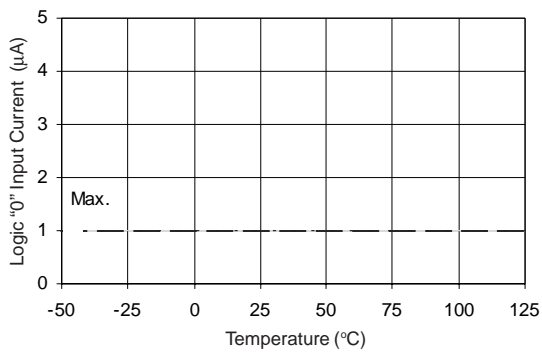

Figure 20A. Logic "0" Input Current vs Temperature

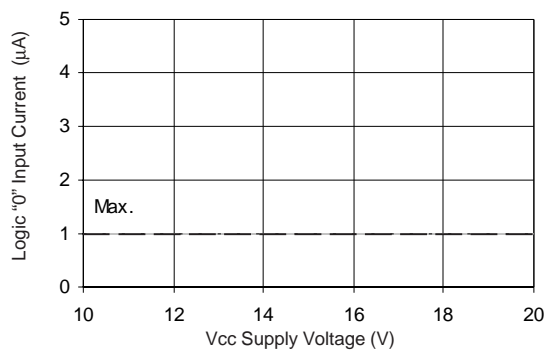

Figure 20B. Logic "0" Input Current vs Voltage

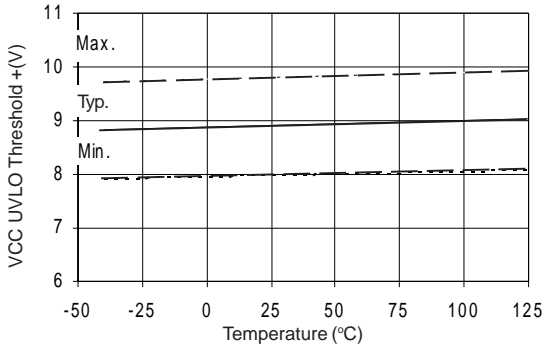

Figure 21A. Vcc Undervoltage Threshold(+) vs Temperature

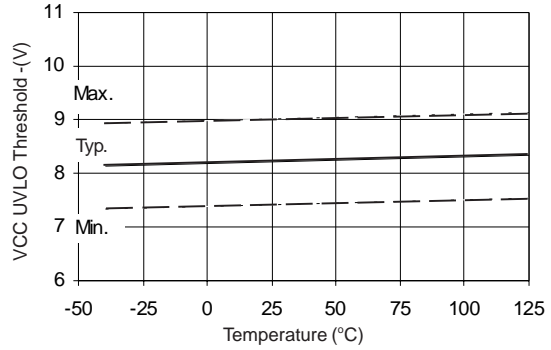

Figure 21B. Vcc Undervoltage Threshold (-) vs Temperature

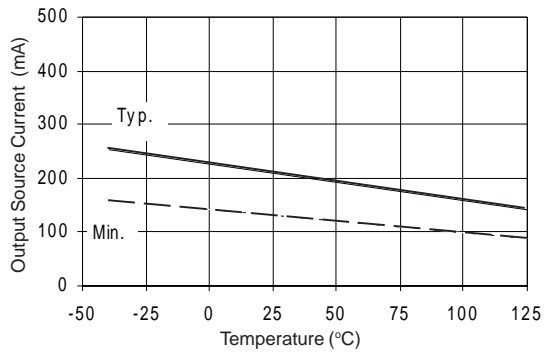

Figure 22A. Output Source Current vs Temperature

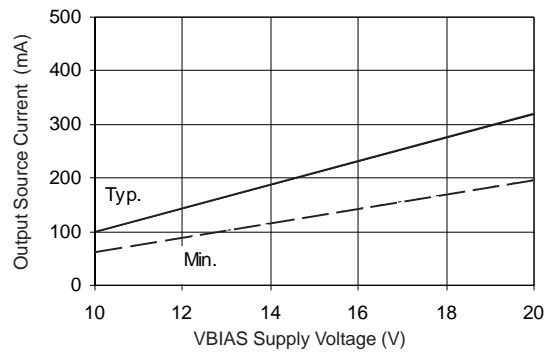

Figure 22B. Output Source Current vs Voltage

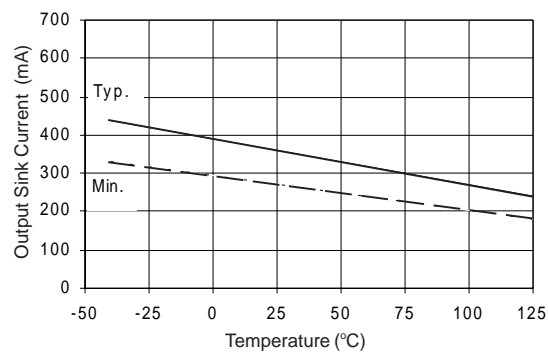

Figure 23A. Output Sink Current vs Temperature

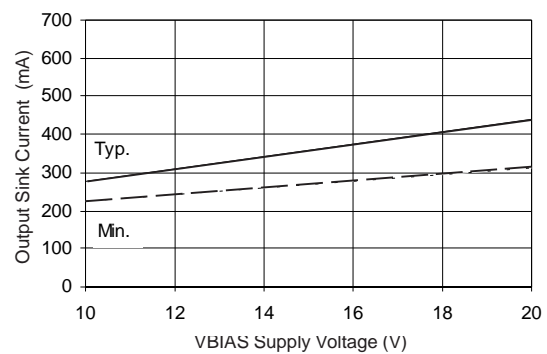
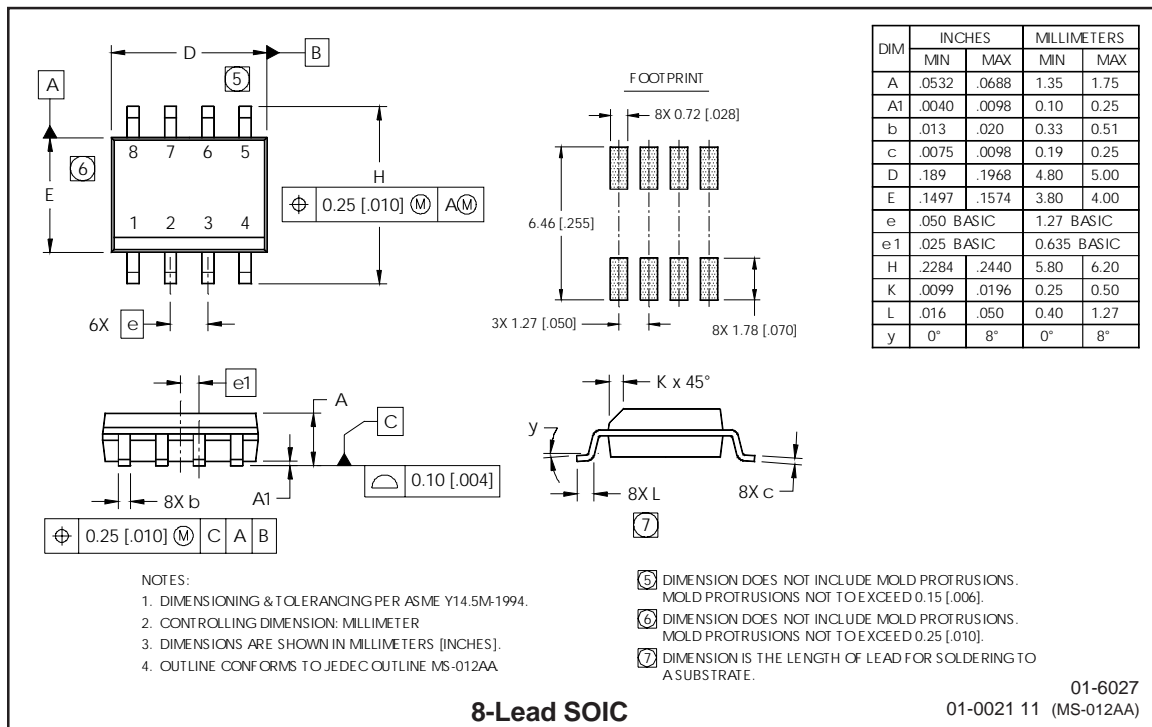
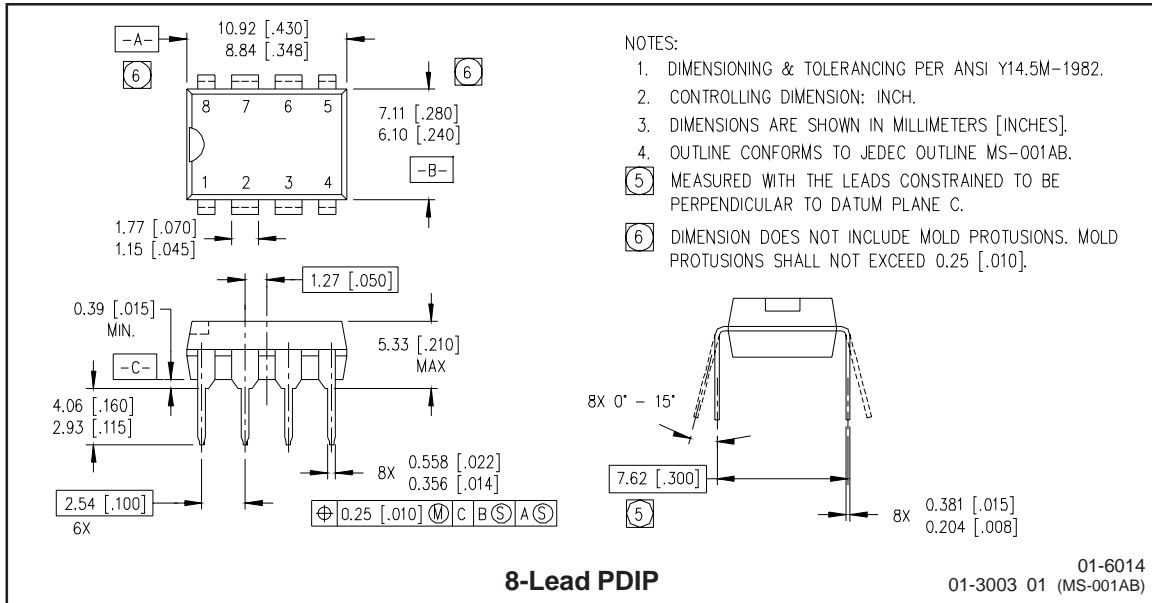

Figure 23B. Output Sink Current vs Voltage

IR2103(S)

International
IR Rectifier



IR WORLD HEADQUARTERS: 233 Kansas St., El Segundo, California 90245 Tel: (310) 252-7105
Data and specifications subject to change without notice. 5/23/2001